

**Masey™**  
LF-049-MC

8" - 20" Widespread Faucet  
Grifo de largo alcance de 8 a 20 pulgadas  
Robinet Élongé de 8 à 20 po.

## Quick Installation Guide Guía de Instalación Rápida Guide d'Installation Rapide



Installation Support • Soporte de Instalación • Support d'Installation

Personal Assistance, Product Specs, & "How-to" Questions:

Asistencia personal, especificaciones del producto y preguntas sobre "cómo hacerlo":

Aide personnelle, spécifications du produit et questions « pratico-pratiques » :

**1-800-PFAUCET (732-8238)**

**pfisterfaucets.com/support**

Installation Videos Available  
Videos de instalación a disposición  
Vidéos d'installation disponibles



pfisterfaucets.com/videos



**WARNING / ADVERTENCIA / AVERTISSEMENT**

To reduce the risk of injury or property damage, read all instructions before installing product. Wear safety goggles. Product must be installed in accordance with all state & local plumbing & building codes. Call a professional if you are uncertain about installing this product.

Para disminuir el riesgo de lesiones o daños a la propiedad, lea todas las instrucciones antes de instalar el producto. Utilice gafas de seguridad. El producto deberá instalarse de acuerdo con la normativa de plomería y construcción estatal y local. Llame a un profesional si no está seguro sobre cómo instalar este producto.

Pour réduire le risque de blessures ou de dommages, lire toutes les instructions avant d'installer le produit. Portez des lunettes de sécurité. Il faut installer le produit en respectant tous les codes de construction et de plomberie locaux et d'état. Appelez un professionnel si vous n'êtes pas certain de la façon d'installer ce produit.

### Required Tools Herramientas necesarias Outils nécessaires

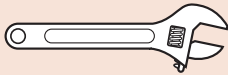

Adjustable Wrench  
Llave ajustable  
Clé à Mollette



Safety Goggles  
Gafas de seguridad  
Lunettes de sûreté

### Additional Helpful Tools Otras herramientas útiles Outils supplémentaires utiles



Flashlight  
Linterna  
Lampe-torche



Cloth  
Paño  
Chiffon

### Parts in the Box Piezas en la caja Pièces dans la boîte

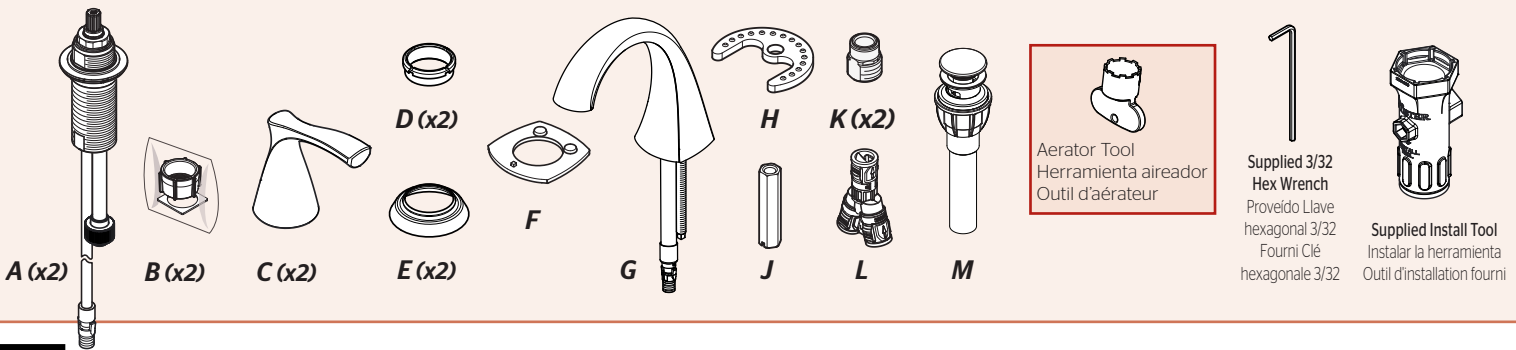

Aerator Tool  
Herramienta aireador  
Outil d'aérateur



Supplied 3/32 Hex Wrench  
Proveído Llave hexagonal 3/32  
Fourni Clé hexagonale 3/32

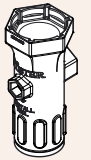

Supplied Install Tool  
Instalar la herramienta  
Outil d'installation fourni

## 1 Turn Off Water Supply • Cierre el suministro de agua • Couper l'alimentation en eau



Locate water supply inlets and shut off the water supply valves. These are usually found under the sink or near the water meter. If you are replacing an existing faucet, remove the old faucet from the sink and clean the sink surface thoroughly.

Ubique las entradas del suministro de agua y cierre las válvulas de suministro de agua. Generalmente se encuentran debajo del fregadero o cerca del medidor de agua. Si se trata de un reemplazo de grifo, quite el grifo viejo y limpie completamente la superficie del fregadero.

Recherchez les entrées d'approvisionnement et fermer leurs robinets. Ces robinets se trouvent généralement sous l'évier ou près du compteur d'eau. Si vous remplacez un robinet existant, retirez, le vieux robinet et nettoyer soigneusement la surface de l'évier.

Hot  
Caliente  
Chaud

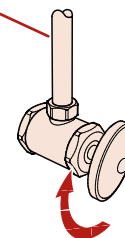

Cold  
Fría  
Froid

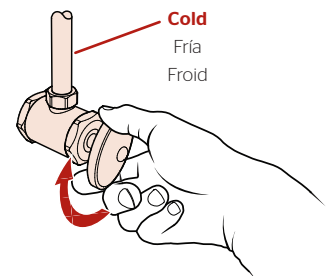

# 2

## Valve Installation Instalación de las válvulas Montage des valves

No Tools Required for This Step  
No se necesitan herramientas para este paso  
Pas d'outil nécessaire pour cette étape

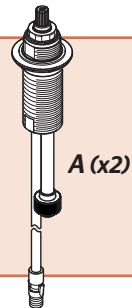

2A

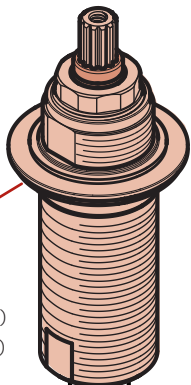

**HOT (RED)**  
CALIENTE (ROJO)  
CHAUD (ROUGE)

**The HOT valve, with Red Ring should be positioned to the left side of the spout.**

La válvula del agua CALIENTE, con el anillo rojo, debe colocarse a la izquierda del surtidor.

La valve d'eau CHAUDE, avec l'anneau rouge, doit être placée sur le côté gauche du bec.

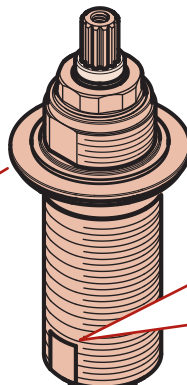

**COLD (BLUE)**  
FRÍA (AZUL)  
FROID (BLEUE)

x2

**Location of flats may vary.**

Localización de el plano puede ser diferente.  
Localisation de la fente peut être différent

2B

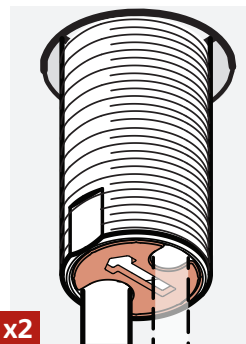

x2

**Position valve arrow to face sink, this ensures handle will be aligned.**

Posicione la flecha para enfrentar el fregadero, esto asegura manivela estará alineada.

Positionnez la flèche pour faire face à l'évier ce qui assure poignée est aligné.

### 3 Secure Valve Bodies & Install Handles

#### Asegurar el cuerpo de la válvula y instale las manijas

#### Fixez les corps de valve et Installez les poignées

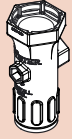

Supplied Install Tool  
Instalar la herramienta  
Outil d'installation fourni



Supplied 3/32 Hex Wrench  
Proveído Llave hexagonal 3/32  
Fourni Clé hexagonale 3/32

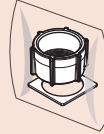

B (x2)



C (x2)



D (x2)



E (x2)

3A

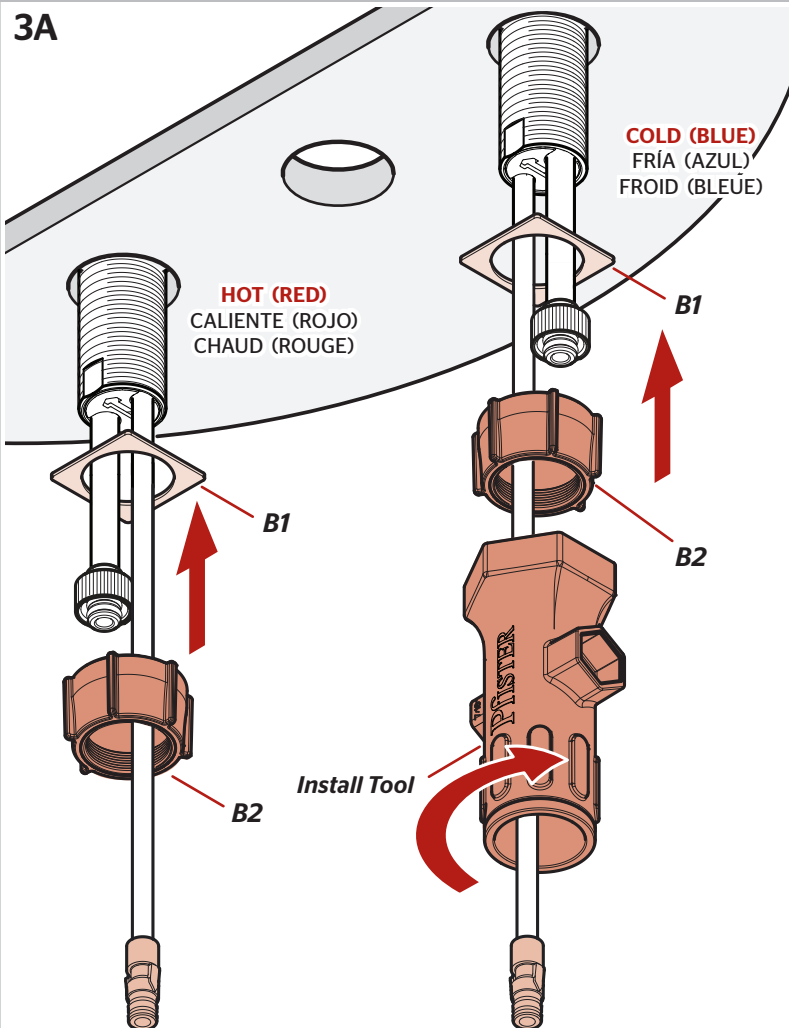

3B

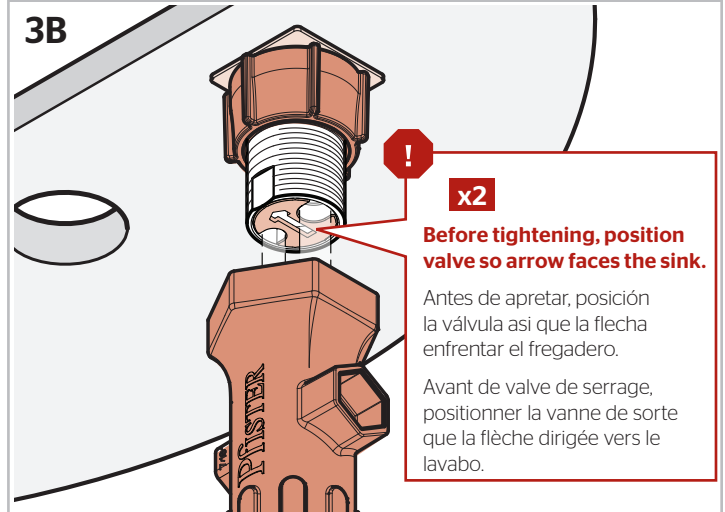

3C

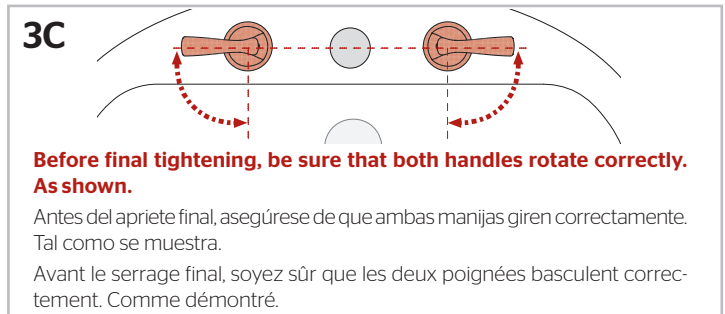

3D

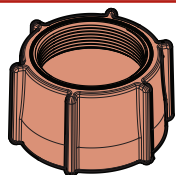
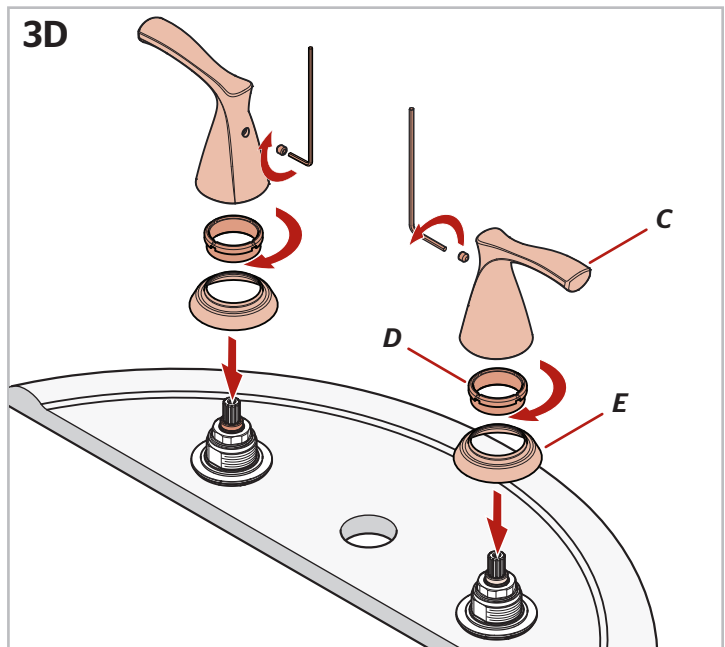

Use nut with threads up for decks up to 2" thick.

Utilice la tuerca con rosca para cubiertas de hasta 51mm de espesor.  
Utiliser l'écrou avec filetage pour les ponts jusqu'à 51mm d'épaisseur.

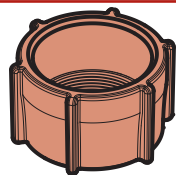

Use nut with threads down for decks up to 1-1/2 thick.

Utilice la tuerca con rosca hacia abajo para cubiertas de hasta 38mm de espesor.  
Utiliser l'écrou avec des fils vers le bas pour les terrasses jusqu'à 38mm d'épaisseur.



If deck is thicker than 2", order Valve Extension Kit 900-058 / 900-059.

Si la plataforma es más gruesa de 51mm, por favor pida la pieza de repuesto 900-058 / 900-059.

Si le pont est plus épais que 51mm, SVP commandez le kit d'extension 900-058 / 900-059.

**4** Install Spout  
 Instale el surtidor  
 Installez le bec

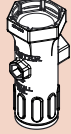

Supplied Install Tool  
 Instalar la herramienta  
 Outil d'installation fourni

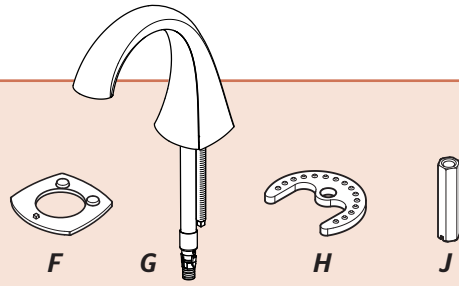

4A

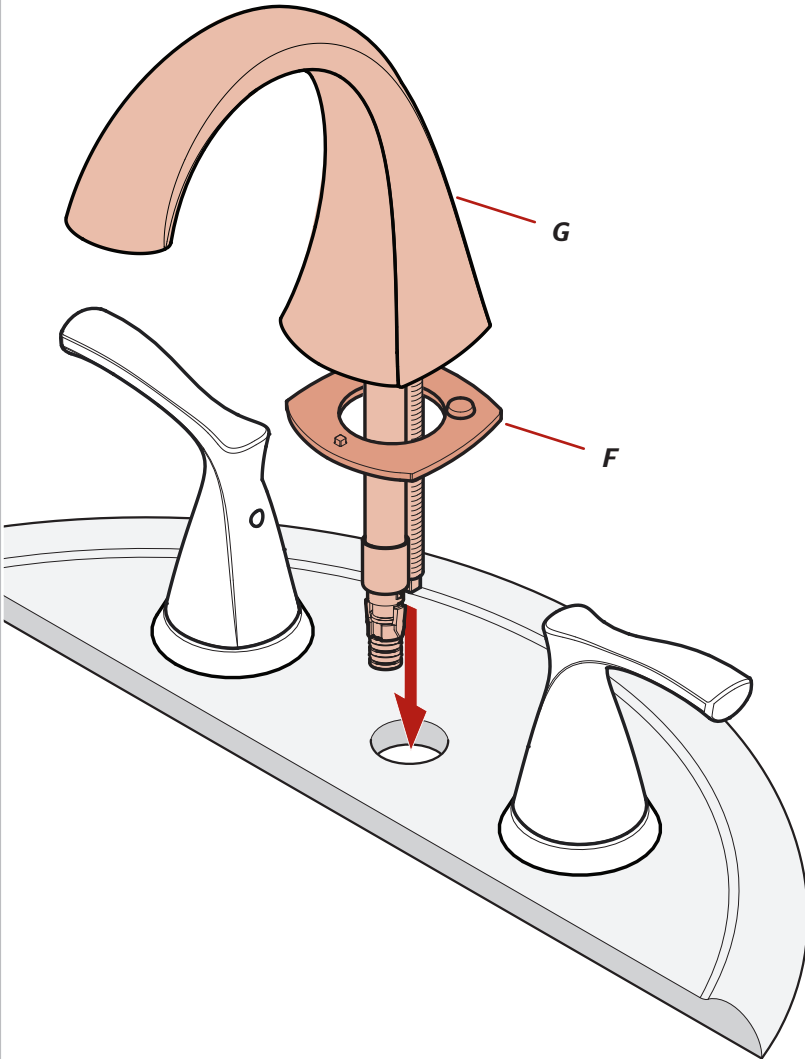

4C

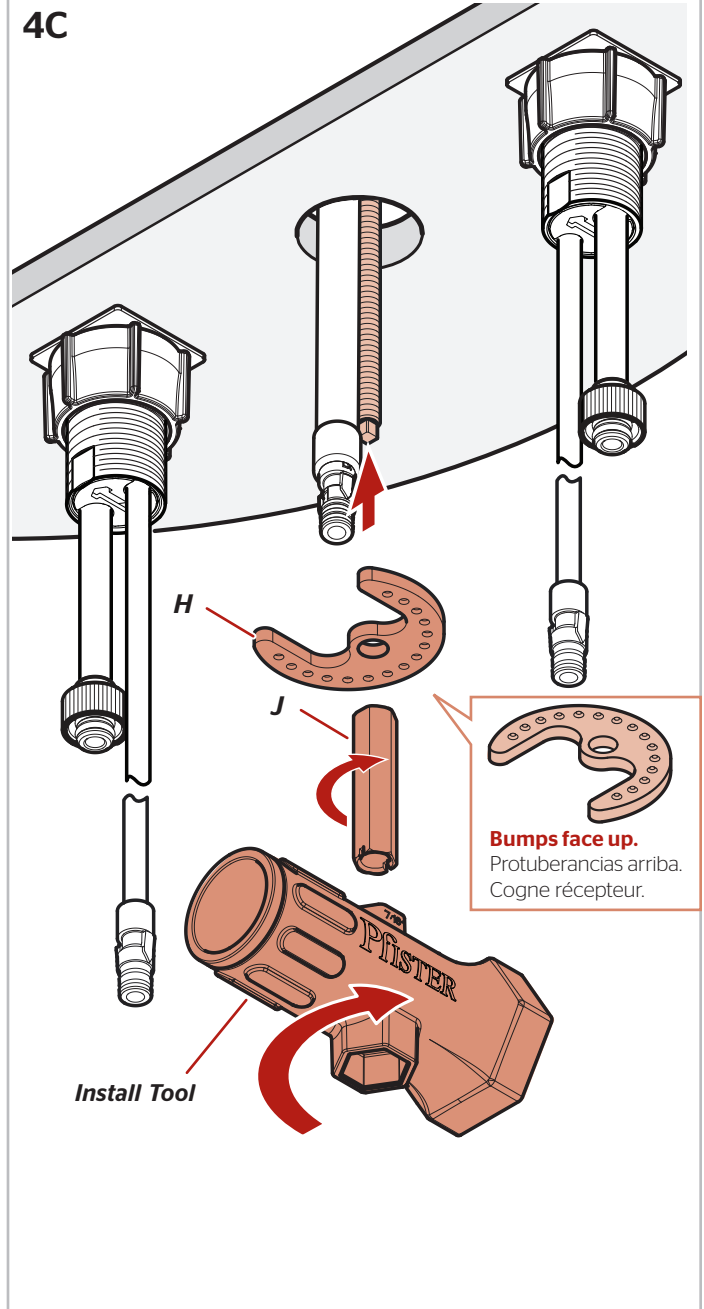

# 5

## Hose Connections

### Conecciones de la manguera

### Connexions des tuyaux

No Tools Required for This Step  
 No se necesitan herramientas para este paso  
 Pas d'outil nécessaire pour cette étape



L

#### 5A

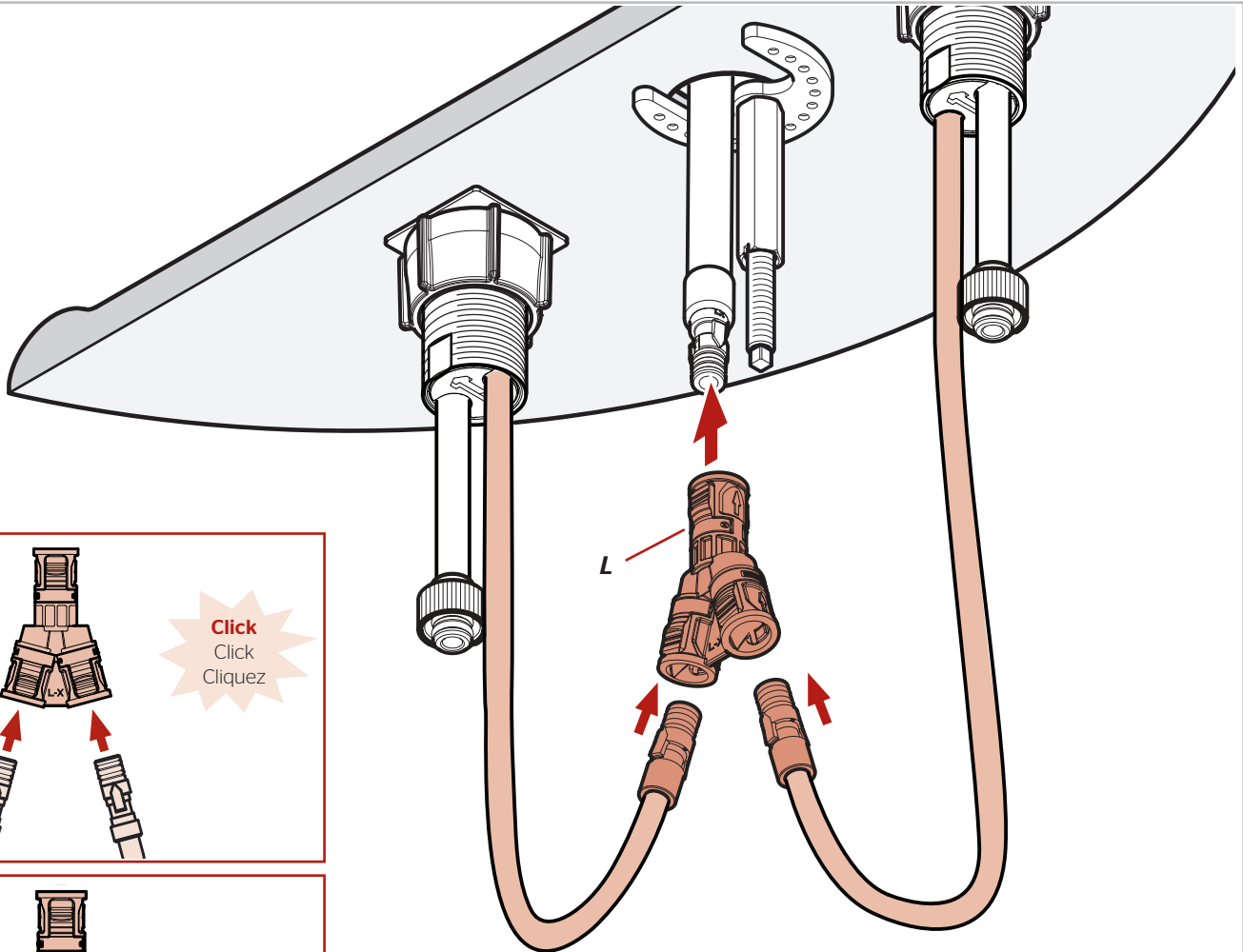

#### 5B

**Click**  
 Click  
 Cliquez

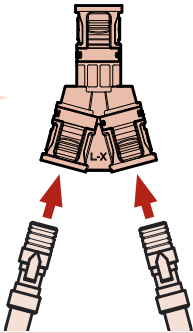

**Click**  
 Click  
 Cliquez

#### 5C



**Check that connections are secure by pulling down on the tubes while avoiding buttons. They should not come off the spout connector.**

Compruebe que las conexiones estén aseguradas tirando abajo de los tubos evitando botones. No deben salir de la conexión del surtidor.

Vérifiez que les connexions sont sécurisées en tirant vers le bas les tubes en évitant les leviers. Ils ne doivent pas laisser la connexion bec.

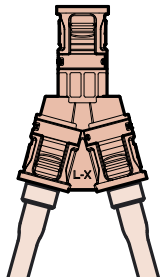

#### 5D

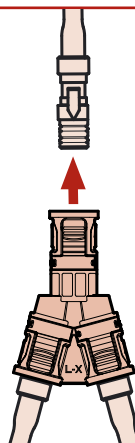

#### 5E



**Check that the connection is secure by pulling down on the spout connector.**

Compruebe que la conexión es segura tirando hacia abajo el conector de boquilla.

Assurez-vous que la connexion est sécurisée en tirant le connecteur de la buse.

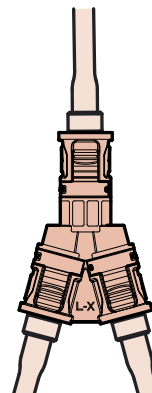

## 6 Connect Water Supply Lines Conecte las tuberías de suministro de agua Raccorder les conduites d'alimentation en eau

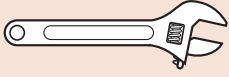

Adjustable Wrench  
Llave ajustable  
Clé à Mollette



Supplied Install Tool  
Instalar la herramienta  
Outil d'installation fourni

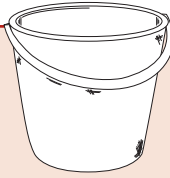

Bucket  
Balde  
Seau

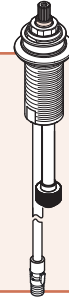

A



K (x2)

**!** Water Supply Lines not included. Please consult manufacturer and/or its instructions for the correct method of installation of supply lines & fittings. **IMPORTANT: Incorrect application of supply lines and fittings may result in the failure or leak of the supply lines and fitting.**

Las tuberías de suministro de agua no están incluidas. Consulte por favor el fabricante y/o sus instrucciones para el método correcto de instalación de líneas de suministro y de guarniciones.

**IMPORTANT:** El uso incorrecto de líneas de suministro y de guarniciones puede dar lugar a la falta o al escape de las líneas de suministro y de la guarnición.

Les tuyaux d'arrivée d'eau ne sont pas fournis. Veuillez consulter le fabricant et/ou ses instructions pour la méthode correcte d'installation des conduites d'alimentation en eau et des accessoires.

**IMPORTANT:** Mauvaise application des lignes d'alimentation et accessoires peut entraîner la défaillance ou la fuite.

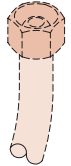

**HOT**  
CALIENTE  
CHAUD

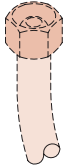

**COLD**  
FRÍA  
FROID

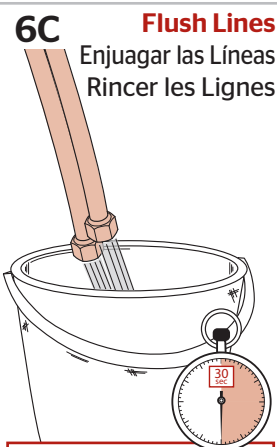
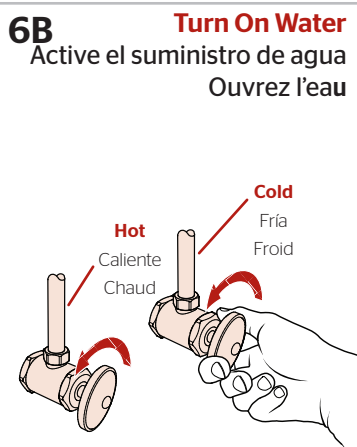
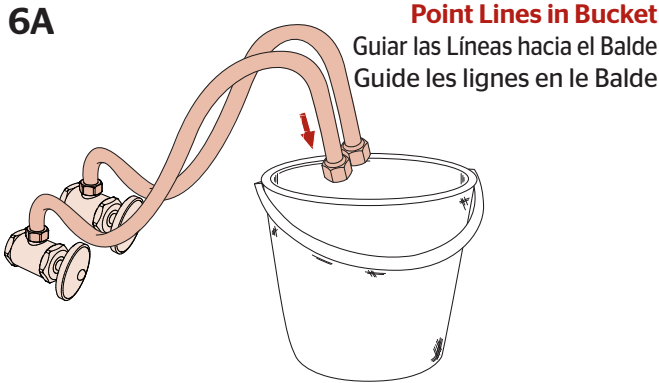

**Allow water to run for at least 30 seconds.**

Deje correr el agua durante al menos 30 segundos.  
Permettez à l'eau couler au moins 30 secondes.

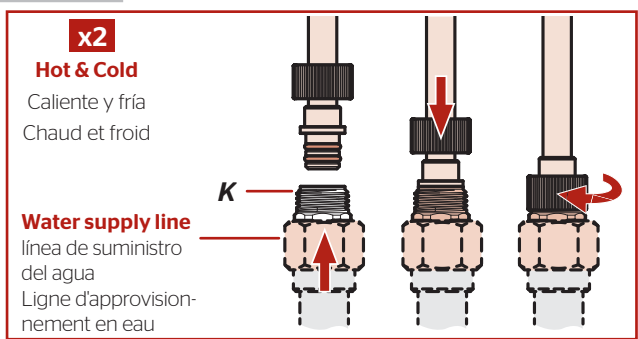
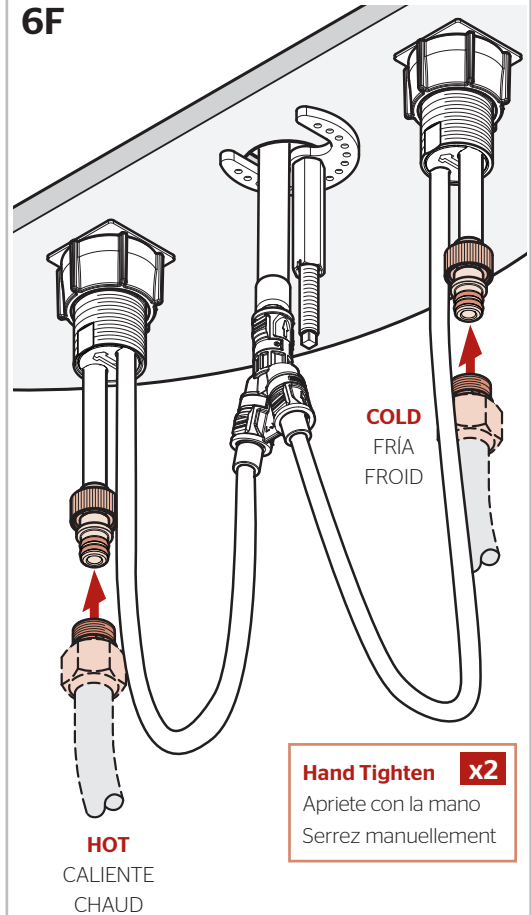
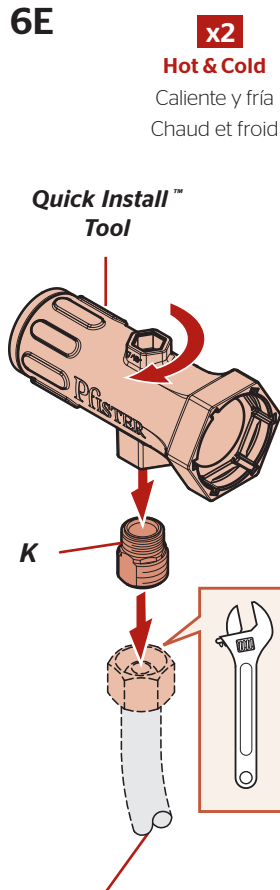
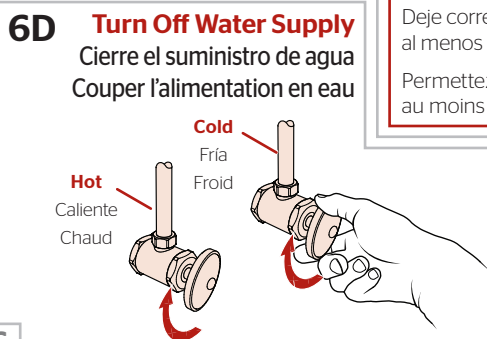

# 7 Prepare & Install Push & Seal™ Drain

## Prepare y instale cuerpo de drenaje Push & Seal™

### Préparez & installez le corps de drainage Push & Seal™

No Tools Required for This Step  
 No se necesitan herramientas para este paso  
 Pas d'outil nécessaire pour cette étape

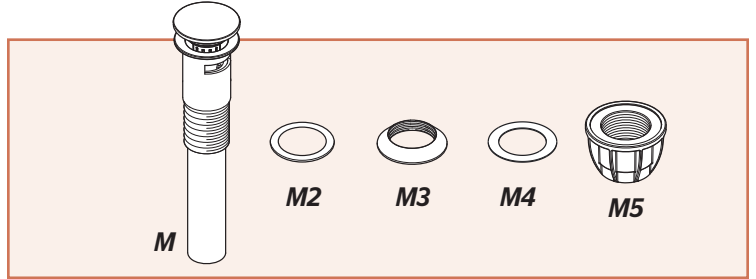

#### 7A Disassemble Pop-Up

##### Desensamble el cuerpo de drenaje

##### Démontez le corps de drainage

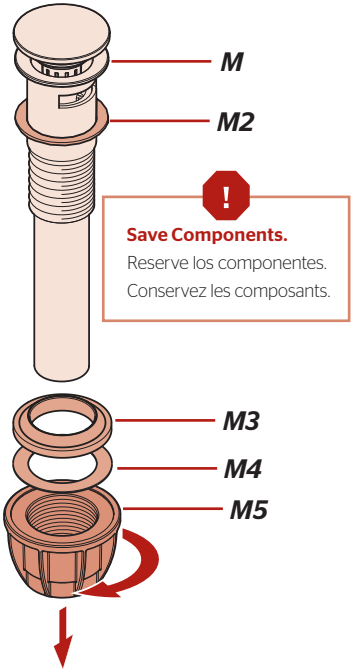

**Save Components.**  
 Reserve los componentes.  
 Conservez les composants.

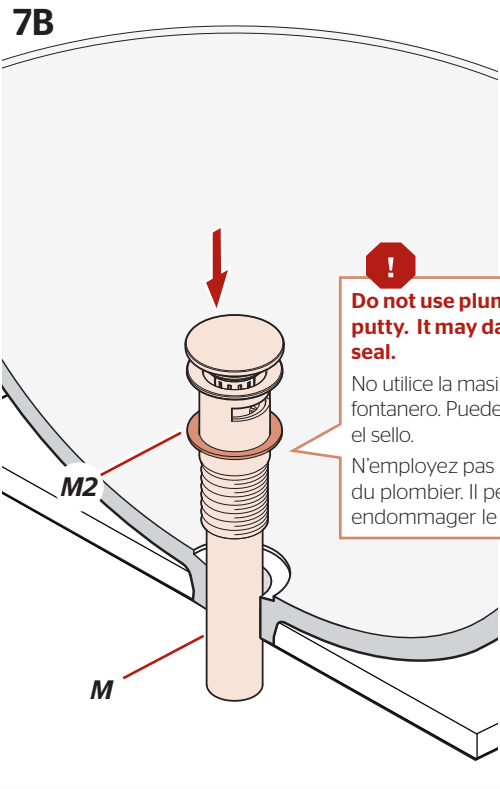

**Do not use plumber's putty. It may damage seal.**  
 No utilice la masilla del fontanero. Puede dañar el sello.  
 N'employez pas le mastic du plombier. Il peut endommager le joint.

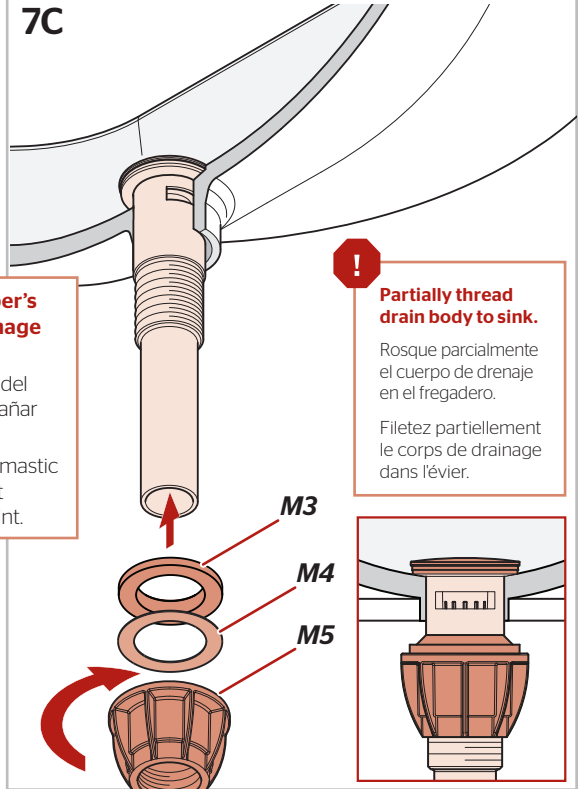

**Partially thread drain body to sink.**  
 Rosque parcialmente el cuerpo de drenaje en el fregadero.  
 Filetez partiellement le corps de drainage dans l'évier.

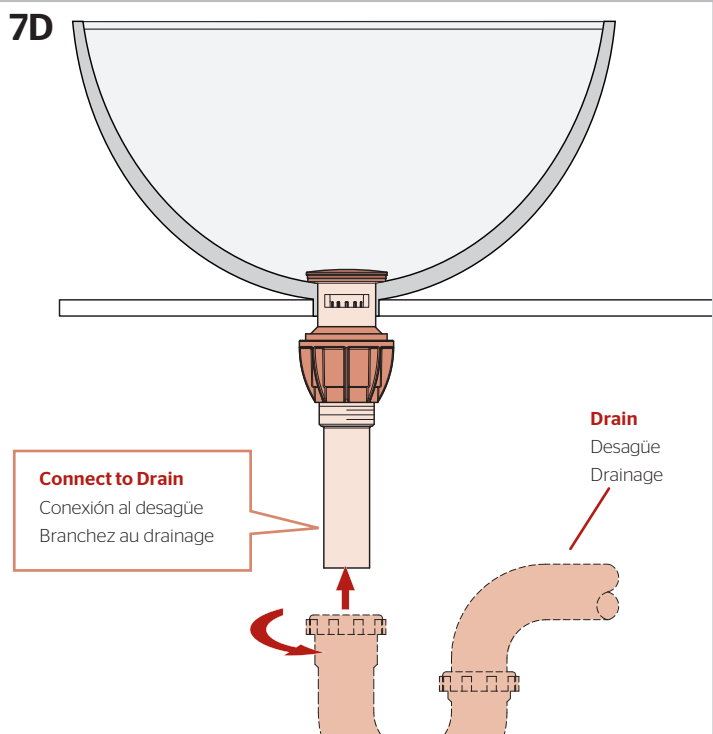

**Connect to Drain**  
 Conexión al desagüe  
 Branchez au drainage

**Drain**  
 Desagüe  
 Drainage

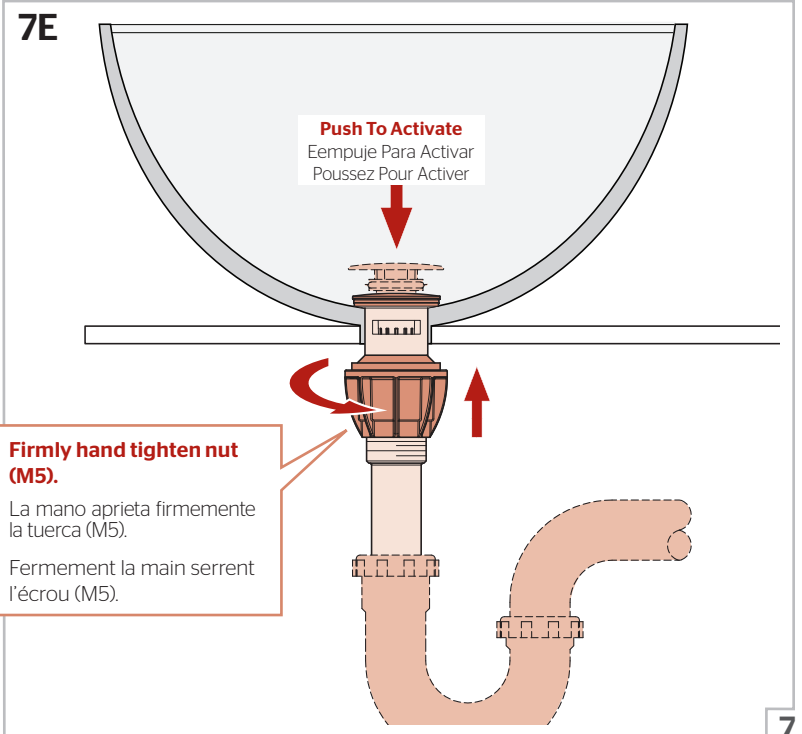

**Firmly hand tighten nut (M5).**  
 La mano aprieta firmemente la tuerca (M5).  
 Fermelement la main serrent l'écrou (M5).

**Push To Activate**  
 Empuje Para Activar  
 Poussez Pour Activer

## 8 Turn On Water & Confirm Proper Installation

Active el suministro de agua y confirme que la instalación está adecuadamente efectuada

Ouvrez l'eau et confirmez que l'installation est correcte

### 8A Remove Aerator

Retire el aereador  
Retirez l'aérateur

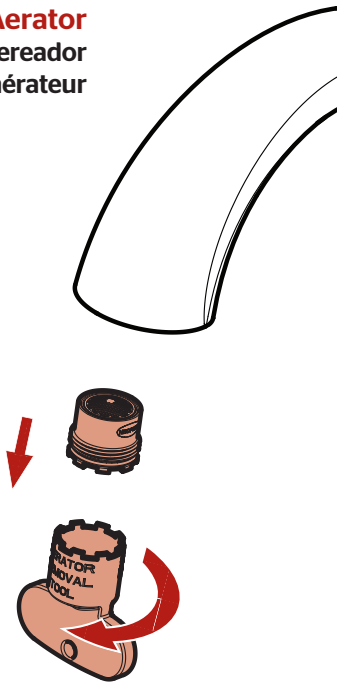

### 8B

### Turn On Water Supply

Abra el suministro de agua  
Ouvrez l'alimentation en eau

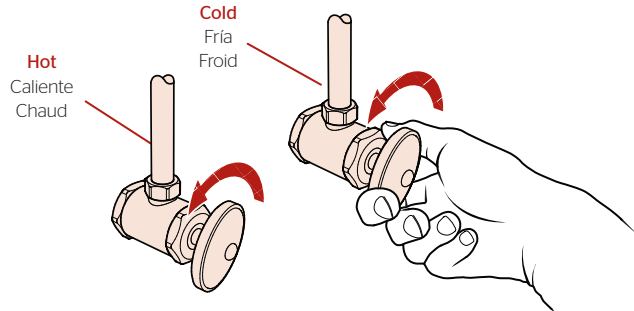

#### Check for leaks above and below the sink.

Revise si hay fugas encima y debajo del fregadero.

Assurez-vous qu'il n'y a pas de fuite au dessus ou au dessous du lavabo.

### 8C Turn On Faucet

Active el grifo  
Ouvrez le robinet

#### Open Slowly

Abra lentamente  
Ouvrez lentement

Open  
Abierta  
Ouvverte

Hot  
Caliente  
Chaud

Cold  
Fría  
Froid

Open  
Abierta  
Ouvverte

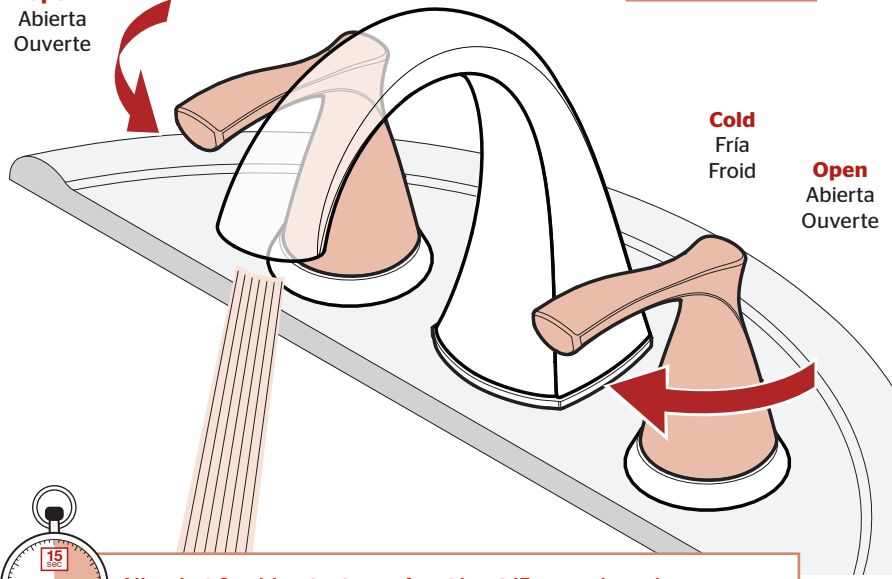

#### Allow hot & cold water to run for at least 15 seconds each.

Deje correr el agua caliente y fría durante al menos 15 segundos cada una.  
Laissez couler l'eau chaude et l'eau froide pendant au moins 15 secondes.

### 8D Reinstall Aerator

Reinstale el aereador  
Réinstallez l'aérateur

#### Hand Tighten

Apriete con la mano  
Serrez manuellement

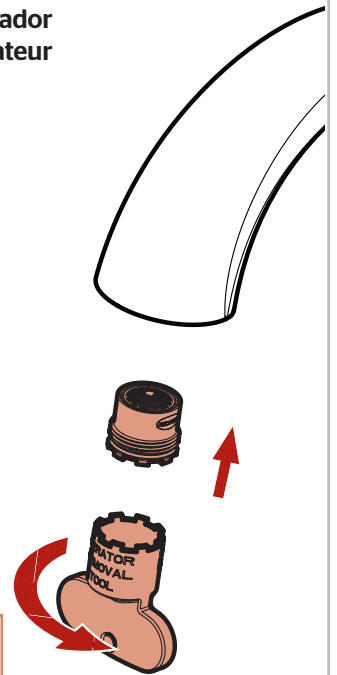

**For Additional Installation Help:**  
Para la instalación adicionales de ayuda:  
Pour les aides supplémentaires à l'installation:

**Pfister**

1-800-PFAUCET (732-8238)  
pfisterfaucets.com